

Manuel d'installation du support de balcon

1. Outils d'installation



Note : L'installation est équipée d'outils.

2. Accessoires pour supports

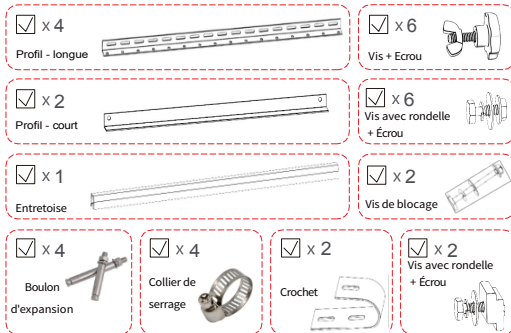

Remarque : les accessoires sont fonction du produit réel.

FEIDER

Créer, faire durer, et perdurer.

3. Installation du support

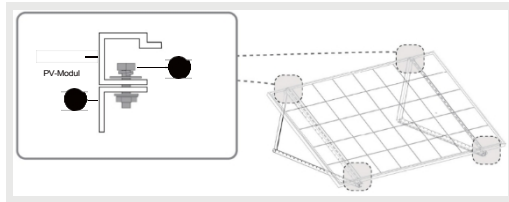
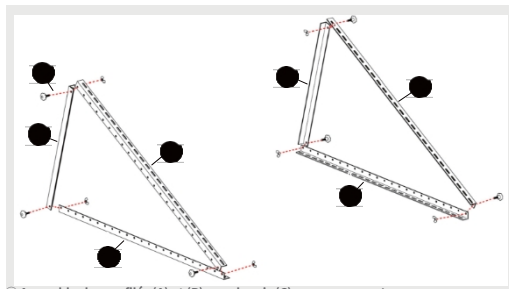

Remarque: l'angle d'inclinaison peut varier en raison des différentes façons dont pro (D) est installé.

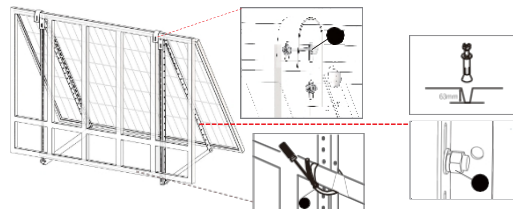
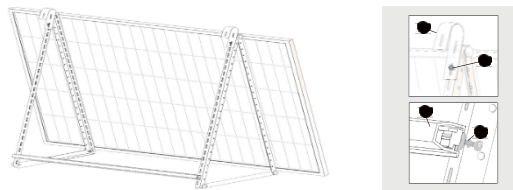

FEIDER

Créer, faire durer, et perdurer.

4. Installation de l'onduleur

1) Montage d'un support au sol. 2) Installation d'un support de balcon



Fixation de l'onduleur au support à l'aide de vis. Utilisez des attaches en acier inoxydable pour fixer l'onduleur à la balustrade.

FEIDER
Adresse : 32 rue Aristide berges, 31270 France
Tel : +33534508508
E-mail : feider@builder-systems.com
www.feider.fr

Balcony Support Installation Manual

FEIDER
Créer, faire durer, et perdurer.

FEIDER
Créer, faire durer, et perdurer.

1. Installation tools



Note: Installation is equipped with tools.

2. Bracket accessories

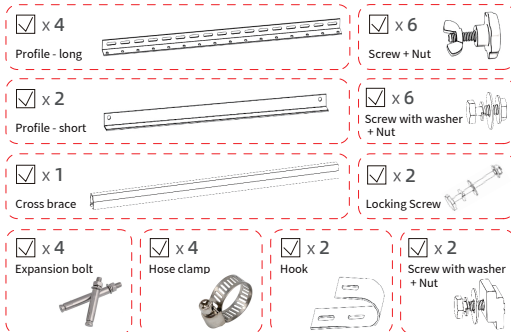

Note: Accessories are subject to actual product

3. Bracket installation

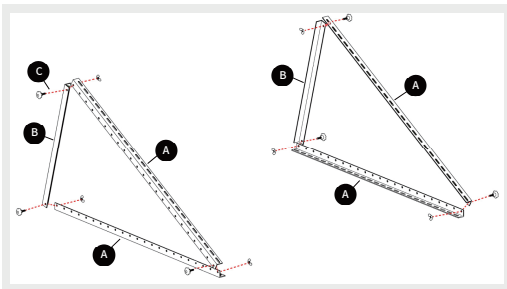

① Assemble the Profiles (A) and (B) with Screws (C) as shown.

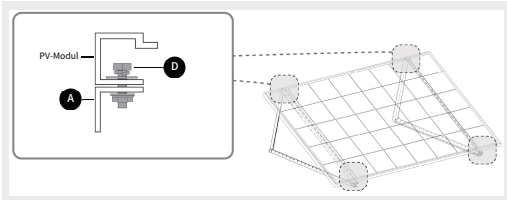

② Now mount the PV-Modul and the Profile (A) with screws and nuts (D).

Notice: The angle of inclination of the can vary due to the different mounting of the Profile (D) can be varied.

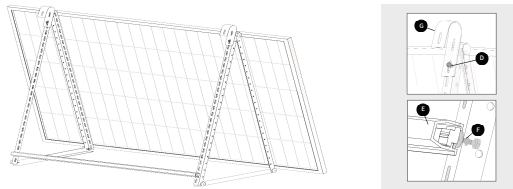

③ Mount the hooks (G) to the Profiles (A) with screws and nuts (D). Then attach the cross brace (E) to the Profiles (A) with screws and cross brace connectors (F).

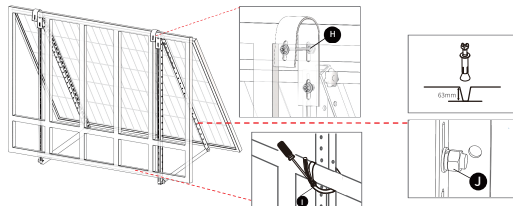

④ Carefully hang the bracket onto the railing. Secure the bracket adequately to the railing. To do this, use the locking screws (H).

4. Inverter installation

1) Floor standing bracket mounting



Fixing the inverter to the bracket using screws

2) Balcony bracket installation



Attaching the inverter to the railing using stainless steel ties

FEIDER
Adresse : 32 rue Aristide berges, 31270 France
Tel : +33534508508
E-mail : feider@builder-systems.com
www.feider.fr

Installationshandbuch für Balkonstützen

1. Installationswerkzeuge



Hinweis: Die Installation ist mit Werkzeugen ausgestattet.

2. Halterungszubehör

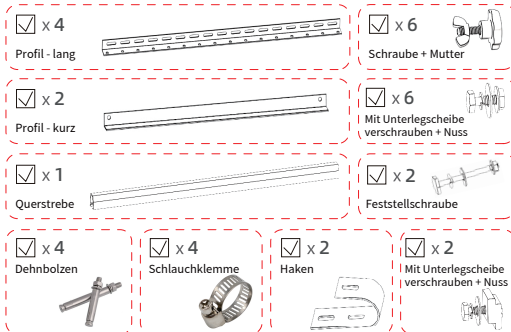

Hinweis: Zubehör unterliegt dem tatsächlichen Produkt

3. Montage der Halterung

FEIDER
Créer, faire durer, et perdurer.

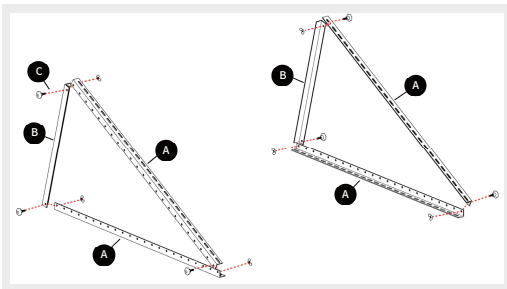

1) Montieren Sie die Profile (A) und (B) mit Schrauben (C) wie gezeigt.

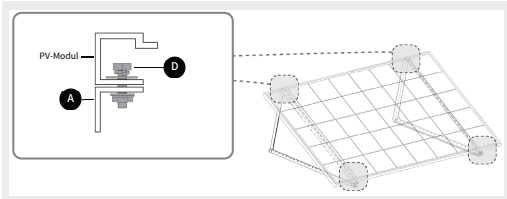

2) Montieren Sie nun das PV-Modul und das Profil (A) mit Schrauben und Muttern (D).

Hinweis: Der Neigungswinkel der Dose kann aufgrund unterschiedlicher Abmessungen variieren. Die Montage des Profils (D) kann variiert werden.

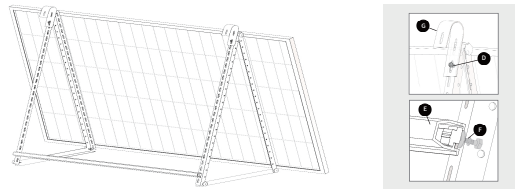

3) Befestigen Sie die Haken (G) mit Schrauben und Muttern (D) an den Profilen (A). Befestigen Sie dann die Querstrebe (E) mit Schrauben und Querstrebenverbindern (F) an den Profilen (A).

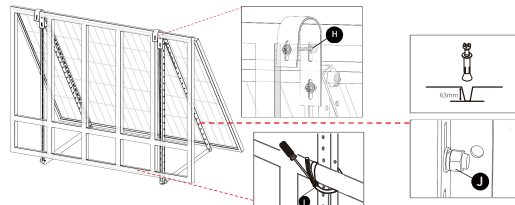

4) Hängen Sie die Halterung vorsichtig am Geländer ein. Befestigen Sie die Halterung ausreichend am Geländer. Benutzen Sie dazu die Feststellschrauben (H).

4. Installation des Wechselrichters

1) Bodenstehende Halterungsmontage 2) Installation der Balkonhalterung



Befestigen des Wechselrichters mit Schrauben an der Halterung



Befestigen des Wechselrichters am Geländer mit Edelstahlbinder

FEIDER
Adresse : 32 rue Aristide berges, 31270 France
Tel : +33534508508
E-mail : feider@builder-systems.com
www.feider.fr